

# Temposonics®

## Magnetostrictive Linear Position Sensors

### R-Series V

#### Brief Instructions



I AM THE NEW GENERATION

### Table of contents

<b>1. Introduction</b> .....	3
1.1 Purpose and use of this manual.....	3
1.2 Used symbols and warnings.....	3
<b>2. Safety instructions</b> .....	4
2.1 Intended use.....	4
2.2 Foreseeable misuse.....	4
2.3 Installation, commissioning and operation.....	5
2.4 Safety instructions for use in explosion-hazardous areas.....	5
2.5 Warranty.....	5
2.6 Return.....	5
2.7 Maintenance & removal.....	5
<b>3. Identification</b> .....	6
3.1 Temposonics® RP5.....	6
3.2 Temposonics® RH5.....	6
<b>4. Installation &amp; mounting</b> .....	7
4.1 Magnet installation.....	7
4.2 Mounting dimensions.....	8
4.3 Multi-position measurement distances.....	9
<b>5. Electrical connections &amp; LED status</b> .....	10
5.1 PROFINET.....	10
5.2 EtherNet/IP™.....	12
5.3 SSI.....	14
5.4 POWERLINK.....	14
5.5 EtherCAT®.....	16
5.6 Analog.....	18

## 1. Introduction

### 1.1 Purpose and use of this manual

Before starting the operation of Temposonics® position sensors, read this documentation thoroughly and follow the safety information. Keep this manual for future reference!

The content of this technical documentation is intended to provide information on mounting, installation and commissioning by qualified automation personnel<sup>1</sup> or instructed service technicians who are familiar with the project planning and dealing with Temposonics® position sensors.

### 1.2 Used symbols and warnings

Warnings are intended for your personal safety and for avoidance of damage to the described product or connected devices. In this documentation, safety information and warnings to avoid danger that might affect the life and health of operating or service personnel or cause material damage are highlighted by the pictogram, defined below.

Symbol	Meaning
<b>NOTICE</b>	This symbol is used to point to situations that may lead to material damage, but not to personal injury.

- 1/ The term “qualified technical personnel” characterizes persons who:
- are familiar with the safety concepts of automation technology applicable to the particular project
  - are competent in the field of electromagnetic compatibility (EMC)
  - have received adequate training for commissioning and service operations
  - are familiar with the operation of the device and know the information required for correct operation provided in the product documentation

## 2. Safety instructions

### 2.1 Intended use

This product may be used only for the applications defined under item 1 and only in conjunction with the third-party devices and components recommended or approved by MTS Sensors. As a prerequisite of proper and safe operation, the product requires correct transport, storage, mounting and commissioning and must be operated with utmost care.

1. The sensor systems of all Temposonics® series are intended exclusively for measurement tasks encountered in industrial, commercial and laboratory applications. The sensors are considered as system accessories and must be connected to suitable evaluation electronics, e.g. a PLC, IPC, indicator or other electronic control unit.

### 2.2 Foreseeable misuse

Foreseeable misuse	Consequence
Wrong sensor connection	The sensor will not work properly or can be damaged
Operate the sensor out of the operating temperature range	No signal output – the sensor can be damaged
Power supply is out of the defined range	Signal output is wrong / no signal output / the sensor will be damaged
Position measurement is influenced by an external magnetic field	Signal output is wrong
Cables are damaged	Short circuit – the sensor can be destroyed / sensor does not respond
Spacers are missing / installed in a wrong order	Error in position measurement
Wrong connection of ground / shield	Signal output is disturbed – the electronics can be damaged
Use of a magnet that is not specified by MTS Sensors	Error in position measurement

**Do not alter the sensor subsequently.**  
→ The sensor might be damaged.

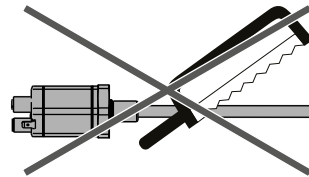
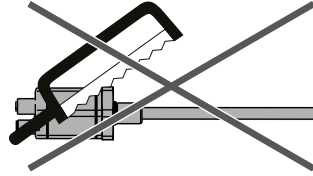

**Do not step on the sensor.**  
→ The sensor might be damaged.

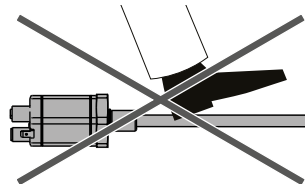
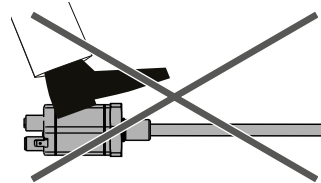

### 2.3 Installation, commissioning and operation

The position sensors must be used only in technically safe conditions. To maintain this condition and to ensure safe operation, installation, connection and service, work may be performed only by qualified technical personnel. If danger of injury to persons or of damage to operating equipment is caused by sensor failure or malfunction, additional safety measures such as plausibility checks, limit switches, EMERGENCY STOP systems, protective devices etc. are required. In the event of trouble, shut down the sensor and protect it against accidental operation.

#### **Safety instructions for commissioning**

To maintain the sensor's operability, it is mandatory to follow the instructions given below.

1. Protect the sensor against mechanical damage during installation and operation.
2. Do not open or dismantle the sensor.
3. Connect the sensor very carefully and pay attention to the polarity of connections and power supply.
4. Use only approved power supplies.
5. Ensure the sensor is operating within the defined limits for supply voltage, environmental conditions, etc..
6. Check the function of the sensor regularly and provide documentation of the checks.
7. Before applying power, ensure that nobody's safety is jeopardized by starting machines.

### 2.4 Safety instructions for use in explosion-hazardous areas

The sensors are not suitable for operation in explosion-hazardous areas.

### 2.5 Warranty

MTS Sensors grants a warranty period <sup>2</sup> for the Temposonics® position sensors and supplied accessories relating to material defects and faults that occur despite correct use in accordance with the intended application. The MTS Sensors obligation is limited to repair or replacement of any defective part of the unit. No warranty can be provided for defects that are due to improper use or above average stress of the product, as well as for wear parts. Under no circumstances will MTS Sensors accept liability in the event of offense against the warranty rules, no matter if these have been assured or expected, even in case of fault or negligence of the company.

MTS Sensors explicitly excludes any further warranties. Neither the company's representatives, agents, dealers nor employees are authorized to increase or change the scope of warranty.

### 2.6 Return

For diagnostic purposes, the sensor can be returned to MTS Sensors or a repair facility explicitly authorized by MTS Sensors. Any shipment cost is the responsibility of the sender <sup>2</sup>. For a corresponding form, see detailed operation manual (available at: [www.mtssensors.com](http://www.mtssensors.com)).

#### **NOTICE**

When returning sensors, place protective caps on male and female connectors of the sensor. For pigtail cables, place the cable ends in a static shielding bag for electrostatic discharge (ESD) protection. Fill the outer packaging around the sensor completely to prevent damage during transport.

### 2.7 Maintenance & removal

Further information about maintenance and removal is provided in the sensor specific operation manuals.

<sup>2/</sup> See also applicable MTS Sensors terms of sales and delivery on: [www.mtssensors.com](http://www.mtssensors.com)

### 3. Identification

#### Nameplate (e.g. R-Series V SSI)

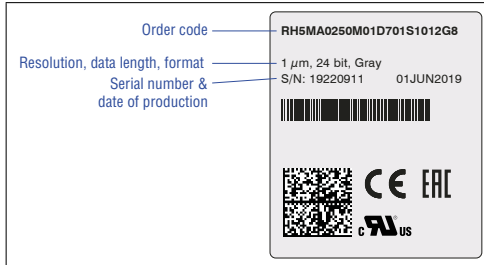

#### Approvals and certificates

You will find approvals and certificates in the sensor specific operation manuals.

#### 3.1 Temposonics® RP5 (profile housing)

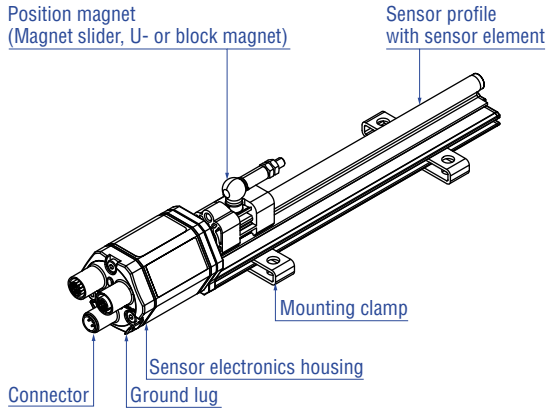

#### Available outputs:

- PROFINET
- EtherNet/IP™
- SSI
- POWERLINK
- EtherCAT®
- Analog

#### 3.2 Temposonics® RH5 (rod housing)

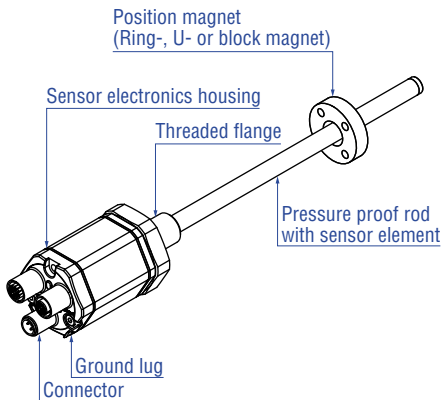



#### Available outputs:

- PROFINET
- EtherNet/IP™
- SSI
- POWERLINK
- EtherCAT®
- Analog

Manuals, Software & 3D models available at:  
[www.mtssensors.com](http://www.mtssensors.com)

## 4. Installation & mounting

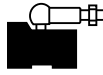
Magnet	Typical sensors	Benefits
 <b>Ring magnets</b>	<b>Rod model</b> (RH5)	<ul style="list-style-type: none"> <li>Rotationally symmetrical magnetic field</li> </ul>
 <b>U-magnets</b>	<b>Profile &amp; rod models</b> (RP5, RH5)	<ul style="list-style-type: none"> <li>Height tolerances can be compensated, because the magnet can be lifted off</li> </ul>
 <b>Block magnets</b>	<b>Profile &amp; rod models</b> (RP5, RH5)	<ul style="list-style-type: none"> <li>Height tolerances can be compensated, because the magnet can be lifted off</li> </ul>
 <b>Magnet sliders</b>	<b>Profile models</b> (RP5)	<ul style="list-style-type: none"> <li>The magnet is guided by the profile</li> <li>The distance between the magnet and the waveguide is strictly defined</li> <li>Easy coupling via the ball joint</li> </ul>

### 4.1 Magnet installation

Install the magnet using non-magnetic material for mounting device, screws, spacers etc.. The magnet must not grind on the sensor rod. Alignment errors are compensated via the air gap.

- Permissible surface pressure: 40 N/mm<sup>2</sup> (only for ring magnets and U-magnets)
- Fastening torque for M4 screws: 1 Nm; use washers, if necessary

#### NOTICE

Mount ring magnets and U-magnets concentrically. Mount block magnets centrally over the sensor rod or the sensor profile. The maximum permissible air gap must not be exceeded. Take care to mount the primary sensor axis in parallel to the magnet path in order to avoid damage to the carriage, magnet and sensor rod/sensor profile.

### Concentric mounting of U-magnet

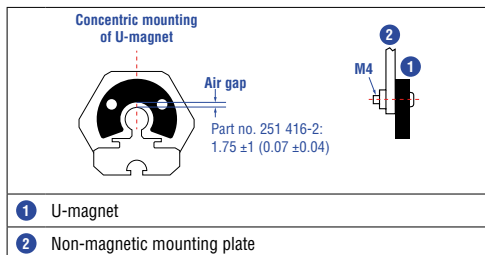

### Centered mounting of block magnet

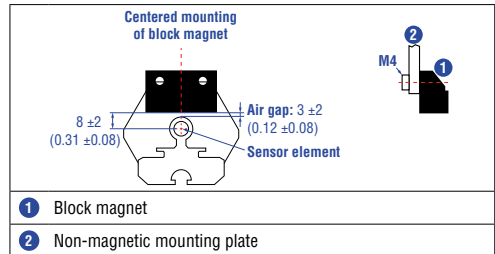

### Magnet mounting with magnetic material

When using magnetic material the dimensions in the drawing beneath must be observed.

- A.** If the position magnet aligns with the drilled piston rod  
**B.** If the position magnet is set further into the drilled piston rod, install another non-magnetic spacer (e.g. part no. 400 633) above the magnet.

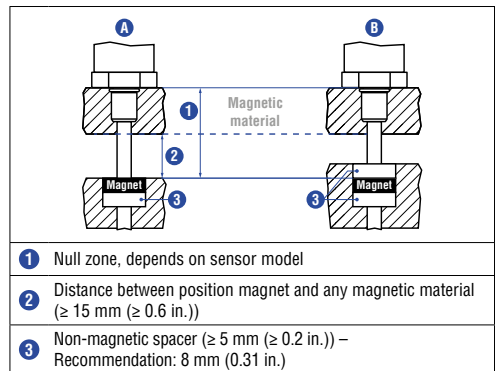

### Sensors with stroke lengths ≥ 1 meter

Support horizontally installed sensors with a stroke length from 1 meter (3.3 ft.) mechanically at the rod end. Without the use of a support, the sensor rod bends and the position magnet may be damaged. A false measurement result is also possible. Longer rods require evenly distributed mechanical support over the entire length (e.g. part no. 561 481). Use an U-magnet for measurement.

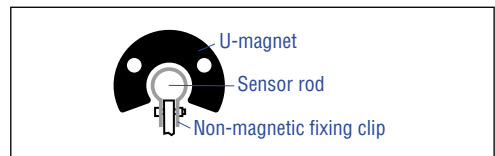

Controlling design dimensions are in millimeters and measurements in ( ) are in inches

## 4.2 Mounting dimensions

### RP5 with magnet slider "S", "N", "V", "G"

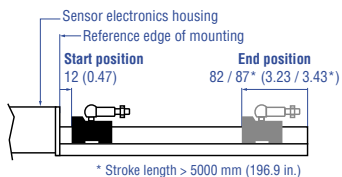

### RP5 with U-magnet

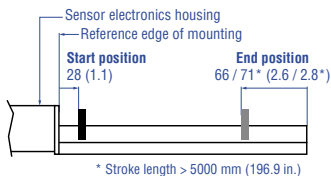

### RP5 with block magnet

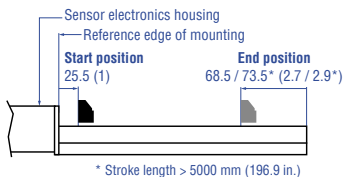

### RH5 with ring magnet/U-magnet

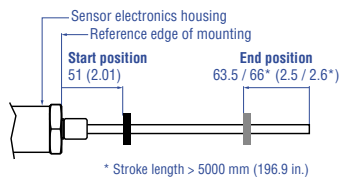

### RH5 with block magnet

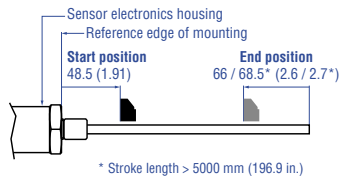

### NOTICE

On all sensors, the areas left and right of the active stroke length are provided for null and dead zone. These zones should not be used for measurement, however the active stroke length can be exceeded.



### 4.3 Multi-position measurement distances

Multi-position measurements are possible depending on the output. It is possible to measure up to 30 positions and their velocities. The stroke length of the sensor influences the maximum number of magnets.

#### RP5 with U-magnets

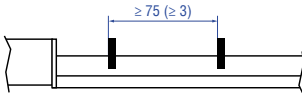

#### RP5 with magnet sliders

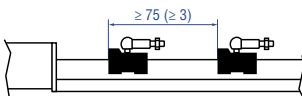

#### RP5 with block magnets

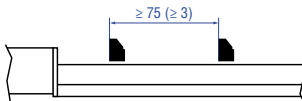

#### RH5 with ring magnets/U-magnets

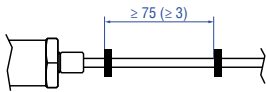

#### RH5 with block magnets

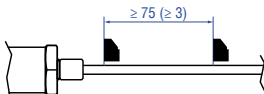

#### NOTICE

For multi-position measurement, use magnets of the same type e.g. 2 × U-magnet (part no. 251 416-2). Do not fall below the minimum distance between the magnets of 75 mm (3 in.) for multi-position measurement. Contact MTS Sensors if you need a magnet distance < 75 mm (3 in.).

### 5. Electrical connections & LED status

Placement of installation and cabling have decisive influence on the sensor's electromagnetic compatibility (EMC). Hence correct installation of this active electronic system and the EMC of the entire system must be ensured by using suitable metal connectors, shielded cables and grounding. Overvoltages or faulty connections can damage its electronics despite protection against wrong polarity.

#### NOTICE

1. Do not mount the sensors in the area of strong magnetic or electric noise fields.
2. Never connect / disconnect the sensor when voltage is applied.

#### Instructions for connection

- Use low-resistant twisted pair and shielded cables. Connect the shield to ground externally via the controller equipment.
- Keep control and signal cables separate from power cables and sufficiently far away from motor cables, frequency inverters, valve lines, relays, etc..
- Use only connectors with metal housing and connect the shielding to the connector housing.
- Keep the connection surface at both shielding ends as large as possible. Connect the cable clamps to function as a ground.
- Keep all non-shielded leads as short as possible.
- Keep the earth connection as short as possible with a large cross section. Avoid ground loops.
- With potential differences between machine and electronics earth connections, no compensating currents are allowed to flow across the cable shielding.  
Recommendation:  
Install potential compensating leads with large cross section, or use cables with separate double shielding, and connect only one end of the shield.
- Use only stabilized power supplies in compliance with the specified electrical ratings.

#### Grounding of profile and rod sensors

Connect the sensor electronics housing to machine ground. Ground sensor types RP5 and RH5 via ground lug. In addition you can ground the sensor type RH5 via thread.

#### Sensor grounding

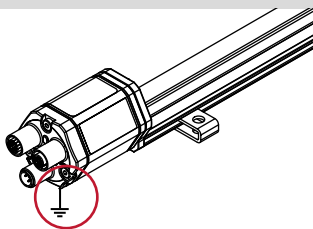

#### 5.1 PROFINET

##### D58

##### Port 1 – Signal

M12 female connector (D-coded)	Pin	Function
<p>View on sensor</p>	1	Tx (+)
	2	Rx (+)
	3	Tx (-)
	4	Rx (-)
	5	Not connected

##### Port 2 – Signal

M12 female connector (D-coded)	Pin	Function
<p>View on sensor</p>	1	Tx (+)
	2	Rx (+)
	3	Tx (-)
	4	Rx (-)
	5	Not connected

##### Power supply

M12 male connector (A-coded)	Pin	Function
<p>View on sensor</p>	1	+12...30 VDC (±20 %)
	2	Not connected
	3	DC Ground (0 V)
	4	Not connected

**PROFINET RT & IRT LED status**

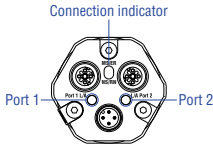

**Device status LED**

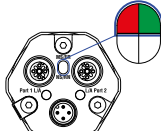

Green	Red	Information
● ON	○ OFF	No error
○ OFF	● ON	Operating voltage out of range or magnet error

**Bus status LED**

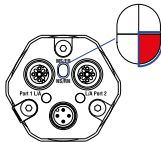

Red	Information
○ OFF	No error
● ON	No connection to controller
◐ Flashing	Parameterization error

**LED for sensor identification**

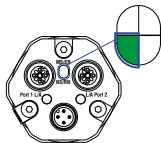

Green	Information
◐ Flashing	Sensor identification activated

**Port 1 L/A**

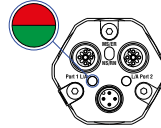

Green	Red	Information
● ON	○ OFF	Connection to the next network node established
● ON	◐ Flashing	Connection to the next network device established & communication active

**Port 2 L/A**

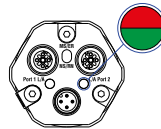

Green	Red	Information
● ON	○ OFF	Connection to the next network node established
● ON	◐ Flashing	Connection to the next network device established & communication active

**Temposonics® R-Series V**  
Brief Instructions

**5.2 EtherNet/IP™**

**D56**

**Port 1 – Signal**

**M12 female connector  
(D-coded)**



Pin	Function
1	Tx (+)
2	Rx (+)
3	Tx (-)
4	Rx (-)
5	Not connected

**Port 2 – Signal**

**M12 female connector  
(D-coded)**



Pin	Function
1	Tx (+)
2	Rx (+)
3	Tx (-)
4	Rx (-)
5	Not connected

**Power supply**

**M8 male connector**



Pin	Function
1	+12...30 VDC (±20 %)
2	Not connected
3	DC Ground (0 V)
4	Not connected

**D58**

**Port 1 – Signal**

**M12 female connector  
(D-coded)**



Pin	Function
1	Tx (+)
2	Rx (+)
3	Tx (-)
4	Rx (-)
5	Not connected

**Port 2 – Signal**

**M12 female connector  
(D-coded)**



Pin	Function
1	Tx (+)
2	Rx (+)
3	Tx (-)
4	Rx (-)
5	Not connected

**Power supply**

**M12 male connector  
(A-coded)**



Pin	Function
1	+12...30 VDC (±20 %)
2	Not connected
3	DC Ground (0 V)
4	Not connected

**EtherNet/IP™ LED status**

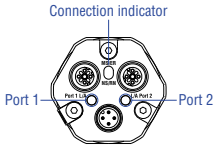

**Module status LED**

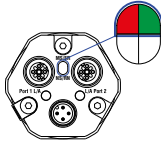

Green	Red	Information
● ON	○ OFF	IP address configured
● Flashing	○ OFF	IP address not configured
○ OFF	● Flashing	Duplicate of IP address recognized

**Network status LED**

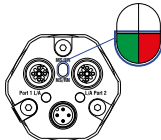

Green	Red	Information
● ON	○ OFF	Connection established
● Flashing	○ OFF	No connection
○ OFF	● ON	Unrecoverable error
○ OFF	● Flashing	Recoverable error

**Port 1 L/A (IN)**

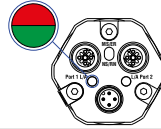

Green	Red	Information
● ON	○ OFF	LINK activity on port 1
● Flickers	○ OFF	Data transfer on port 1
○ OFF	● ON	No magnet / wrong quantity of magnets

**Port 2 L/A (OUT)**

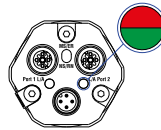

Green	Red	Information
● ON	○ OFF	LINK activity on port 2
● Flickers	○ OFF	Data transfer on port 2

# Temposonics® R-Series V

## Brief Instructions

### 5.3 SSI

#### D70

Signal + power supply

M16 male connector	Pin	Function
 <p>View on sensor</p>	1	Data (-)
	2	Data (+)
	3	Clock (+)
	4	Clock (-)
	5	+12...30 VDC (±20 %)
	6	DC Ground (0 V)
	7	Not connected

#### HXX / PXX / RXX / TXX

Signal + power supply

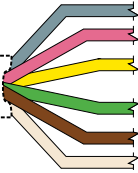
Cable	Color	Function
	GY	Data (-)
	PK	Data (+)
	YE	Clock (+)
	GN	Clock (-)
	BN	+12...30 VDC (±20 %)
	WH	DC Ground (0 V)

#### R-Series V SSI LED status

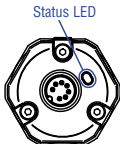

Time slot 1	Time slot 2	Time slot 3	Time slot 4	Information
GN	BU	RD	Off	Configuration error
BU	GN	RD	Off	Storage error
BU	RD	GN	Off	Internal error
RD	Off	RD	Off	Power supply error
BU + GN	BU + GN	BU + GN	BU + GN	Sync status error
GN	Off	GN	Off	Cycle timeout
GN	RD	BU	Off	Extra magnet
RD + GN	RD + GN	RD + GN	RD + GN	Magnet status error
RD	BU	GN	Off	Signal error
RD	GN	BU	Off	Position error
BU	Off	BU	Off	Command mode
GN	GN	GN	GN	Normal function

1 × time slot = 0.5 seconds

### 5.4 POWERLINK

#### D56

Port 1 – Signal

M12 female connector (D-coded)	Pin	Function
 <p>View on sensor</p>	1	Tx (+)
	2	Rx (+)
	3	Tx (-)
	4	Rx (-)
	5	Not connected

Port 2 – Signal

M12 female connector (D-coded)	Pin	Function
 <p>View on sensor</p>	1	Tx (+)
	2	Rx (+)
	3	Tx (-)
	4	Rx (-)
	5	Not connected

Power supply

M8 male connector	Pin	Function
 <p>View on sensor</p>	1	+12...30 VDC (±20 %)
	2	Not connected
	3	DC Ground (0 V)
	4	Not connected

**POWERLINK LED status**

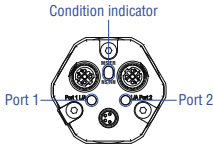

**Device status LED**

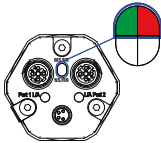

Green	Red	Information
○ OFF	● ON	- Number of magnets differs from configuration - Power supply outside specification
○ OFF	◐ Flashing	- Invalid configuration of the sensor - Internal error

**Bus status LED (when the sensor is started up, these statuses run through)**

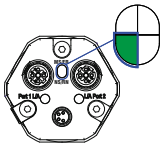

Green	Red	Information
◐ Flashing evenly	○ OFF	Basic Ethernet Mode
◐ Flashing 1x	○ OFF	Preoperational Mode 1
◐ Flashing 2x	○ OFF	Preoperational Mode 2
◐ Flashing 3x	○ OFF	Ready to operate
● ON	○ OFF	Connection establishment completed, sensor connected to controller

**Bus error LED**

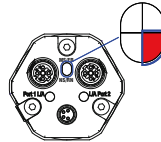

Red	Information
● ON	POWERLINK communication error

**Port 1 L/A**

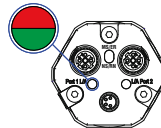

Green	Red	Information
● ON	○ OFF	Connection to the next network node established
◐ Flashing	○ OFF	Connection to the next network node established & communication active

**Port 2 L/A**

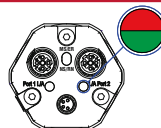

Green	Red	Information
● ON	○ OFF	Connection to the next network node established
◐ Flashing	○ OFF	Connection to the next network node established & communication active

**Temposonics® R-Series V**  
Brief Instructions

**5.5 EtherCAT®**

**D56**

**Port 1 – Signal**

**M12 female connector  
(D-coded)**

**Pin Function**



View on sensor

1	Tx (+)
2	Rx (+)
3	Tx (-)
4	Rx (-)
5	Not connected

**Port 2 – Signal**

**M12 female connector  
(D-coded)**

**Pin Function**



View on sensor

1	Tx (+)
2	Rx (+)
3	Tx (-)
4	Rx (-)
5	Not connected

**Power supply**

**M8 male connector**

**Pin Function**



View on sensor

1	+12...30 VDC (±20 %)
2	Not connected
3	DC Ground (0 V)
4	Not connected

**D58**

**Port 1 – Signal**

**M12 female connector  
(D-coded)**

**Pin Function**



View on sensor

1	Tx (+)
2	Rx (+)
3	Tx (-)
4	Rx (-)
5	Not connected

**Port 2 – Signal**

**M12 female connector  
(D-coded)**

**Pin Function**



View on sensor

1	Tx (+)
2	Rx (+)
3	Tx (-)
4	Rx (-)
5	Not connected

**Power supply**

**M12 male connector  
(A-coded)**

**Pin Function**



View on sensor

1	+12...30 VDC (±20 %)
2	Not connected
3	DC Ground (0 V)
4	Not connected



### EtherCAT® LED status

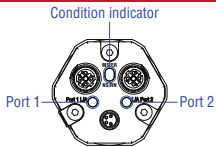

### Error status LED

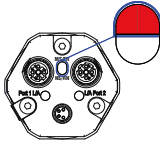

Red	Information
● ON	Critical error
⦿ Flashing 1×	Slave drive state changed
⦿ Flashing 2×	Watchdog timer error
⦿ Blinking	Configuration error
○ OFF	Communication OK

### Run status LED

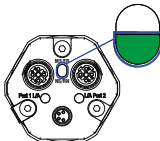

Green	Information
● ON	OP mode
⦿ Flashing 1×	SAFE-OP mode
⦿ Blinking	PRE-OP mode
⦿ Flickering	Booting process
○ OFF	INIT mode

### Port 1 L/A (IN)

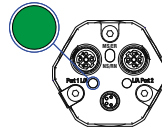

Green	Information
● ON	Link activity on port 1
⦿ Blinking	Data transfer on port 1
○ OFF	Port closed

### Port 2 L/A (OUT)

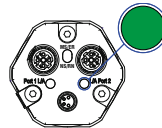

Green	Information
● ON	Link activity on port 2
⦿ Blinking	Data transfer on port 2
○ OFF	Port closed

# Temposonics® R-Series V

## Brief Instructions

### 5.6 Analog

D60			
Signal + power supply			
M16 male connector	Output	Pin	Function
 <p>View on sensor</p>	1	1	Position (magnet 1)
		2	Signal Ground
	2*	3	Position (magnet 2) or reverse position (magnet 1) or speed or velocity (magnet 1) or temperature inside the sensor electronics housing
		4	Signal Ground
		5	+12...30 VDC (±20 %)
		6	DC Ground (0 V)
* order dependent			

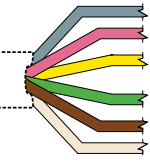
HXX / RXX / TXX			
Signal + power supply			
Cable	Output	Color	Function
	1	GY	Position (magnet 1)
		PK	Signal Ground
	2*	YE	Position (magnet 2) or reverse position (magnet 1) or speed or velocity (magnet 1) or temperature inside the sensor electronics housing
		GN	Signal Ground
		BN	+12...30 VDC (±20 %)
		WH	DC Ground (0 V)
* order dependent			

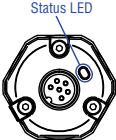
R-Series V Analog LED status				
				
Time slot 1	Time slot 2	Time slot 3	Time slot 4	Information
GN	BU	RD	Off	Configuration error
BU	GN	RD	Off	Storage error
BU	RD	GN	Off	Internal error
RD	Off	RD	Off	Power supply error
GN	Off	GN	Off	Cycle time error
GN	RD	BU	Off	Extra magnet
RD + GN	RD + GN	RD + GN	RD + GN	Magnet status error
RD	BU	GN	Off	Signal error
BU	Off	BU	Off	Command mode
GN	GN	GN	GN	Normal function

1 × time slot = 0.5 seconds

**UNITED STATES** 3001 Sheldon Drive  
**MTS Systems Corporation** Cary, N.C. 27513  
**Sensors Division** Phone: +1 919 677-0100  
Americas & APAC Region E-mail: info.us@mtssensors.com

---

**GERMANY** Auf dem Schüffel 9  
**MTS Sensor Technologie** 58513 Lüdenscheid  
**GmbH & Co. KG** Phone: +49 2351 9587-0  
EMEA Region & India E-mail: info.de@mtssensors.com

---

**ITALY** Phone: +39 030 988 3819  
Branch Office E-mail: info.it@mtssensors.com

---

**FRANCE** Phone: +33 1 58 4390-28  
Branch Office E-mail: info.fr@mtssensors.com

---

**UK** Phone: +44 79 44 15 03 00  
Branch Office E-mail: info.uk@mtssensors.com

---

**SCANDINAVIA** Phone: +46 70 29 91 281  
Branch Office E-mail: info.sca@mtssensors.com

---

**CHINA** Phone: +86 21 2415 1000/2415 1001  
Branch Office E-mail: info.cn@mtssensors.com

---

**JAPAN** Phone: +81 3 6416 1063  
Branch Office E-mail: info.jp@mtssensors.com

---

**Document Part Number:**  
551968 Revision B (EN) 05/2020



[www.mtssensors.com](http://www.mtssensors.com)